

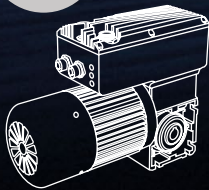

GEAR

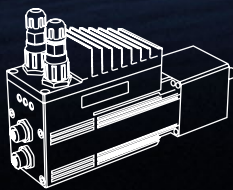

BRUSHLESS



CLEAN

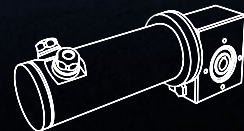

PRODUCT LINE



WE ARE BY YOUR SIDE

TO HELP YOU TURN COMPLEXITY
INTO CLEARNESS.

We are more than suppliers.

We are partners.

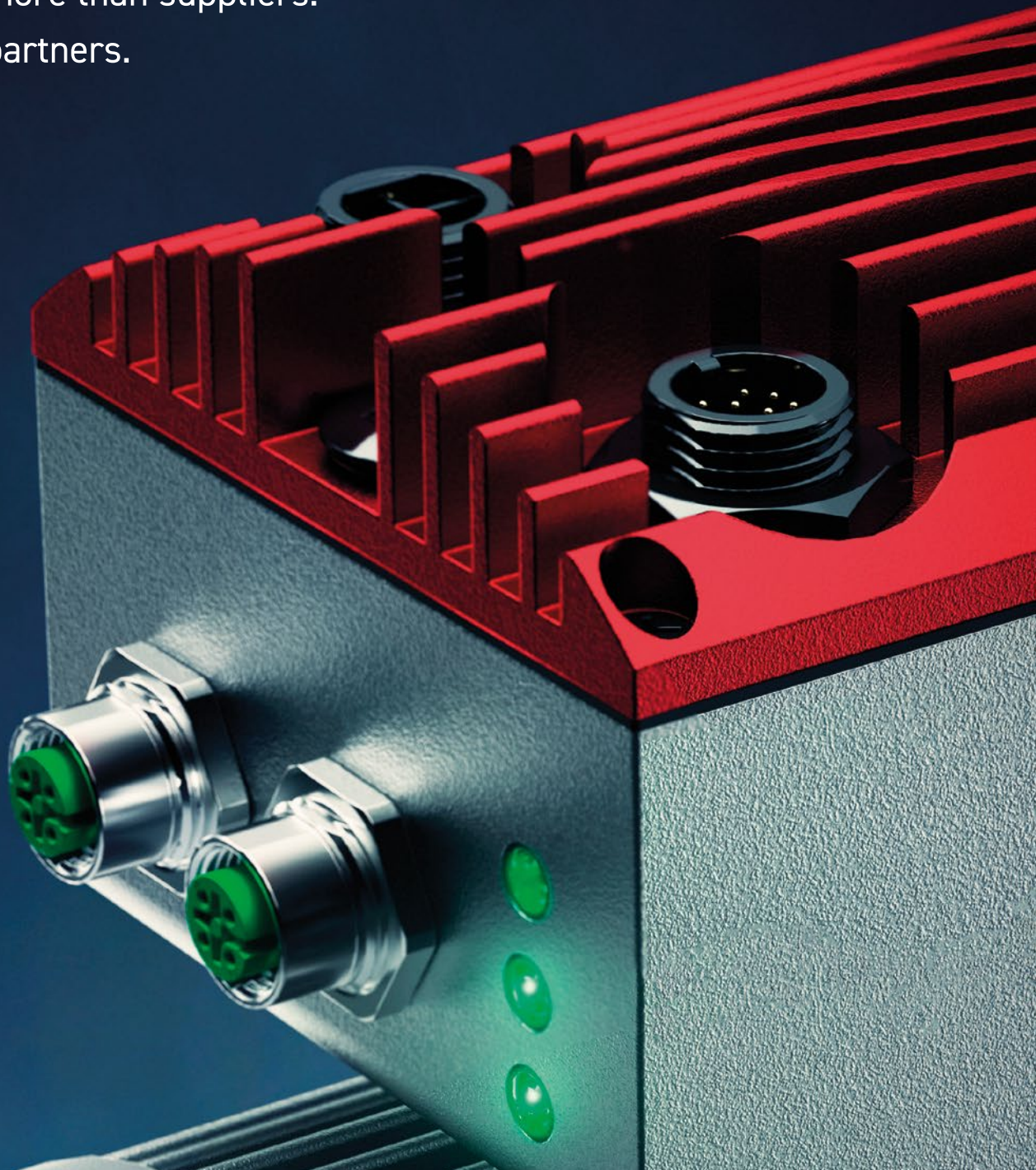

EFFECTIVE INTEGRATION

We link together different applications acting as a coordinated whole within important processes. Our products provide fluid communication that allows multiple systems to talk to each other as needed.

When it comes to full integration, in addition to the economic benefits, the importance of critical factors increases — planning, systems design, software design, requirements, configuration management, testing, and quality control.

Technology innovation has changed the method of message transmission, but has not decreased the need for effective communications. That's why in Mini Motor connectivity also means engaging in a workmates culture: supporting each other and relaying information quickly and effectively is a cornerstone workplace skill.

THIS IS THE CORE
OF INDUSTRY 4.0

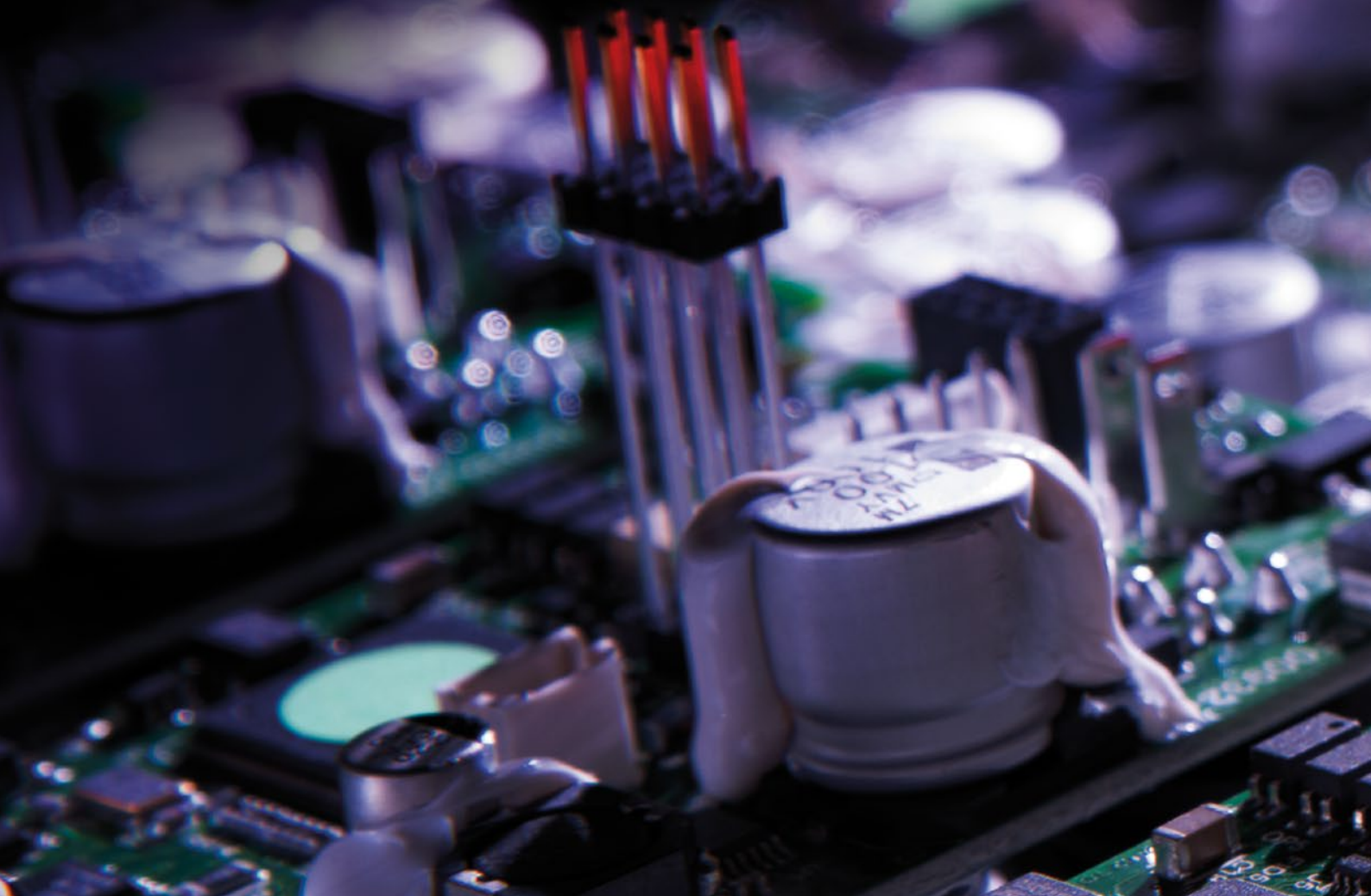



IT EFFECTIVE INTEGRATION

Ecco il cuore dell'Industria 4.0

Connettiamo applicazioni differenti in modo che agiscano come una struttura unitaria e coordinata all'interno dei processi fondamentali. I nostri prodotti garantiscono una comunicazione fluida, che consente a più sistemi di comunicare tra loro in base alle esigenze.

Quando si tratta di piena e reale integrazione, oltre al vantaggio economico, aumenta l'importanza dei fattori critici: pianificazione, progettazione dei sistemi, progettazione del software, requisiti, gestione della configurazione, test e controllo di qualità.

L'innovazione tecnologica ha cambiato il metodo di trasmissione dei messaggi, ma non ha diminuito la necessità di comunicazioni efficaci. Ecco perché, in Mini Motor, connettività vuol dire anche impegnarsi nella collaborazione tra colleghi: dare supporto reciproco e trasmettere informazioni in modo rapido ed efficace sono competenze fondamentali nel nostro ambiente di lavoro.

ES EFFECTIVE INTEGRATION

Aquí está el corazón de la Industria 4.0

Conectamos aplicaciones diferentes para que actúen como una estructura unificada y coordinada dentro de los procesos clave. Nuestros productos garantizan una comunicación fluida, lo que permite que múltiples sistemas se comuniquen entre sí según sea necesario.

Cuando se trata de una integración completa y real, además de la ventaja económica, aumenta la importancia de los factores críticos: planificación, diseño de sistemas, diseño de software, requisitos, administración de configuraciones, pruebas y control de calidad.

La innovación tecnológica ha cambiado la forma en que se transmiten los mensajes, pero no ha disminuido la necesidad de comunicaciones eficaces. Por eso, en Mini Motor, la conectividad también significa establecer colaboraciones: brindar apoyo mutuo y transmitir información de forma rápida y eficaz son competencias clave en nuestro entorno de trabajo.

DE EFFECTIVE INTEGRATION

Das Herzstück der Industrie 4.0

Unterschiedliche Anwendungen werden bei uns so verknüpft, dass sie als einheitliche und koordinierte Struktur innerhalb der Kernprozesse arbeiten. Unsere Produkte stellen eine reibungslose Kommunikation sicher, die den bedarfsgerechten Informationsaustausch mehrerer Systeme ermöglicht.

Eine vollständige, echte Integration bringt neben wirtschaftlichen Vorteilen auch die Verantwortung mit sich, den kritischen Faktoren noch mehr Bedeutung beizumessen, d. h. Planung, Systementwicklung, Softwareentwicklung, Anforderungen, Konfigurationsmanagement sowie Qualitätsprüfung und -kontrolle.

Technologische Innovationen haben die Übertragungsmethode der Informationen verändert, die Notwendigkeit einer effektiven Kommunikation jedoch nicht verringert. Darum bedeutet Konnektivität bei Mini Motor auch, sich aktiv im Team zu engagieren. Gegenseitige Unterstützung und ein rascher, effektiver Informationsaustausch gehören zu den Grundkompetenzen in unserem Arbeitsumfeld.

FR EFFECTIVE INTEGRATION

Le cœur de l'industrie 4.0

Nous connectons différentes applications afin qu'elles agissent comme une structure homogène et coordonnée à l'intérieur de processus fondamentaux. Nos produits garantissent une communication fluide permettant à plusieurs systèmes de communiquer entre eux selon leurs besoins.

Quand il s'agit d'une réelle et totale intégration, l'avantage économique augmente tout comme les facteurs critiques : planification, conception des systèmes, conception du logiciel, exigences, gestion de la configuration, essai et contrôle de la qualité.

L'innovation technologique a changé la méthode de transmission des messages, mais elle n'a pas diminué la nécessité d'une communication efficace. C'est pourquoi chez Mini Motor, connectivité signifie également collaboration entre collègues : s'aider mutuellement et transmettre rapidement et efficacement des informations sont des compétences fondamentales dans notre entreprise.

UNCHAINED ENGINEERING

WE HAVE ALWAYS
LIVED IN THE
FUTURE

Our future began over 50 years ago, in the heart of the Italian motor valley. Since then, we have been cultivating some key ideas: innovation, improvement, and excellence.

But there's more to this. We have always believed in achieving product excellence through excellent production systems. Quality is not a piece of paper. It is a passion that drives us. This is why our certifications are real guarantees of excellence.

Our entire production meet ISO 9001:2015 quality requirements. All our product range also obtained the cCSAus mark, for both Canadian and US markets. Our manufacturing solutions and components achieved the following international protection ratings: IP65, IP67 and, thanks to the new stainless steel series, IP69K.



IT UNCHAINED ENGINEERING **Viviamo nel futuro, da sempre**

Il nostro futuro è iniziato più di 50 anni fa, al centro della motor valley italiana. Da allora, coltiviamo alcune idee chiave: innovazione, miglioramento costante, eccellenza costruttiva.

Ma c'è di più. Da sempre siamo convinti che l'eccellenza di prodotto si ottiene solo con l'eccellenza di processo. La qualità non è un pezzo di carta. È una passione che ci guida in ogni momento. Ecco perché le nostre certificazioni sono garanzia di reale eccellenza.

La nostra produzione è conforme ai requisiti dello standard ISO 9001:2015. Tutta la gamma dei nostri prodotti ha inoltre ottenuto il marchio cCSAus, sia per il mercato canadese sia per quello americano. Grazie alle soluzioni costruttive e ai componenti utilizzati, abbiamo ottenuto i gradi di protezione IP65, IP67 e, infine, con la nuova serie in acciaio inox, IP69K.

ES UNCHAINED ENGINEERING **Vivimos en el futuro, desde siempre**

Nuestro futuro comenzó hace más de 50 años, en el centro del motor valley italiano. Desde entonces, hemos cultivado algunas ideas clave: innovación, mejora constante y excelencia de fabricación.

Pero hay más. Siempre hemos estado convencidos de que la excelencia del producto solo se obtiene con la excelencia del proceso. La calidad no es un trozo un papel. Es una pasión que nos guía en todo momento. Por eso, nuestras certificaciones son una garantía de auténtica excelencia.

Nuestra producción cumple con los requisitos de la norma ISO 9001:2015. Además, toda nuestra gama de productos ha obtenido la marca cCSAus, tanto para el mercado canadiense como para el estadounidense. Gracias a las soluciones constructivas y los componentes utilizados, hemos obtenido los grados de protección IP65, IP67 y, por último, con la nueva serie de acero inoxidable, el IP69K.

DE UNCHAINED ENGINEERING **Zukunft findet bei uns jetzt statt – und zwar schon immer**

Unsere Zukunft begann vor mehr als 50 Jahren im Herzen des italienischen Motor Valley. Seitdem verfolgen wir mit Beständigkeit drei Schlüsselkonzepte: Innovation, kontinuierliche Verbesserung und höchste Fertigungsqualität.

Doch das ist noch nicht alles. Wir sind seit jeher davon überzeugt, dass Spitzenprodukte nur durch höchste Prozessqualität zu erzielen sind. Qualität existiert bei uns nicht nur auf dem Papier, sondern ist eine Leidenschaft, die uns als Leitbild in jeder Situation dient. Darum sind auch unsere Zertifizierungen ein Garant für herausragende Leistungen.

Unsere Produktion erfüllt die Anforderungen der ISO-Norm 9001:2015. Zudem trägt unsere gesamte Produktpalette das Zeichen cCSAus und ist somit sowohl für den kanadischen als auch den US-amerikanischen Markt zugelassen. Dank unserer bautechnischen Lösungen und verwendeten Komponenten entsprechen unsere Produkte den Schutzarten IP65, IP67 und, mit unserer neuen Edelstahlserie, auch IP69K.

FR UNCHAINED ENGINEERING **Nous sommes tournés vers l'avenir, depuis toujours**

Notre avenir a commencé il y a plus de 50 ans, au cœur de la vallée des moteurs italienne. Depuis, nous cultivons quelques idées fondamentales : innovation, amélioration constante, construction sous l'enseigne de l'excellence.

Mais pas seulement. Depuis toujours, nous sommes convaincus qu'un excellent produit ne s'obtient qu'avec un excellent processus. La qualité n'est pas un bout de papier, mais une passion qui nous guide à chaque instant. Voilà pourquoi nos certifications sont la garantie réelle de notre excellence.

Notre production est conforme aux exigences de la norme ISO 9001:2015. De plus, toute la gamme de nos produits a obtenu la certification cCSAus, tant pour le marché canadien que pour le marché américain. Grâce aux solutions de construction et aux composants employés, nous avons obtenu les degrés de protection IP65, IP67 et, avec la nouvelle série en acier inoxydable, IP69K.

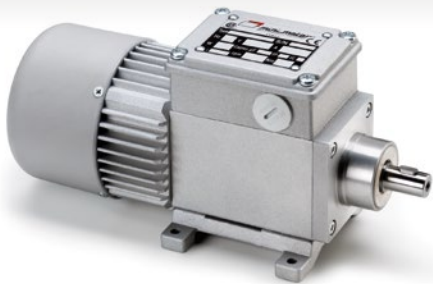
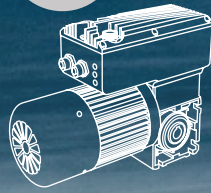

GEAR



AC

- (EN) Coaxial geared motors. Single-phase and three-phase motors from 9 to 74 W.
- (USA) Inline Helical Geared Motors. Single-phase and three-phase motors from 1/56 to 1/9 HP.
- (IT) Motorriduttori coassiali ad ingranaggi. Motori da 9 a 74 W monofasi o trifasi.
- (ES) Motorreductores coaxiales de engranajes. Motores entre 9 y 74 W monofásicos o trifásicos.
- (DE) Koaxiale Zahnrad-Getriebemotoren. Einphasen-oder Drehstrommotoren von 9 bis 74 W.
- (FR) Motorréducteurs coaxiaux à engrenages. Moteurs de 9 à 74 W monophasés ou triphasés.

RPM TORQUE

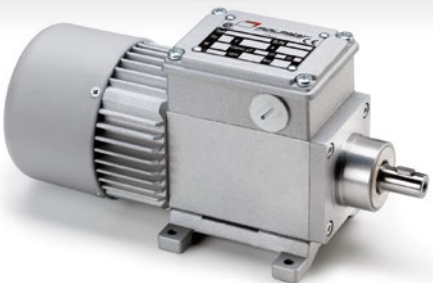

| | | |
|------------------------------------------------------------------------------------|-------------|-------------------|
|  | 3.1 ÷ 378 | 0.4 ÷ 5 Nm |
|  | 3.8 ÷ 453.6 | 3.5 ÷ 44.3 in-lbs |



ACC

- (EN) Coaxial geared motors. 37 W DC motors with permanent magnets.
- (USA) Inline Helical Geared Motors. 1/20 HP DC motors with permanent magnets.
- (IT) Motorriduttori coassiali ad ingranaggi. Motori in corrente continua a magneti permanenti da 37 W.
- (ES) Motorreductores coaxiales de engranajes. Motores en corriente continua con imanes permanentes de 37 W.
- (DE) Koaxiale Zahnrad-Getriebemotoren. Gleichstrommotor mit Dauermagneten mit 37 W.
- (FR) Motorréducteurs coaxiaux à engrenages. Moteurs en courant continu à aimants permanents de 37 W.

RPM TORQUE

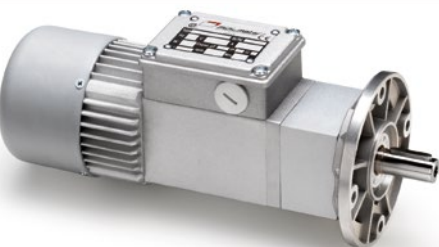

| | | |
|------------------------------------------------------------------------------------|---------|-------------------|
|  | 8 ÷ 378 | 0.9 ÷ 5 Nm |
|  | 8 ÷ 378 | 8.0 ÷ 44.3 in-lbs |



ACE

- (EN) Coaxial geared motors plus final planetary reduction stage. Single-phase and three-phase motors from 9 to 74 W.
- (USA) Inline Helical Geared Motors plus final planetary reduction stage. Single-phase and three-phase motors from 1/56 to 1/9 HP.
- (IT) Motorriduttori coassiali ad ingranaggi più stadio finale epicicloidale. Motori da 9 a 74 W monofasi o trifasi.
- (ES) Motorreductores coaxiales de engranajes más etapa final epicicloidale. Motores entre 9 y 74 W monofásicos o trifásicos.
- (DE) Koaxialer Zahnrad-Getriebemotoren und zusätzlichem Planetenunteretzungsgetriebe. Einphasen-oder Drehstrommotor von 9 bis 74 W.
- (FR) Motorréducteurs coaxiaux à engrenages plus étage final épicycloïdal. Moteurs de 9 à 74 W monophasés et triphasés.

RPM TORQUE

| | | |
|------------------------------------------------------------------------------------|----------|---------------------|
|  | 0.6 ÷ 75 | 2 ÷ 23.5 Nm |
|  | 0.7 ÷ 90 | 17.7 ÷ 208.0 in-lbs |

ACCE

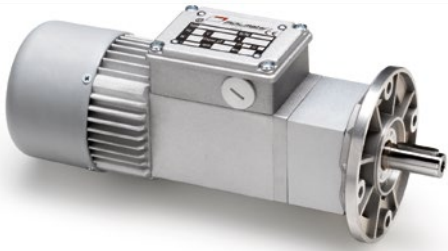

- (EN) Coaxial geared motors plus final planetary reduction stage. 37 W DC motors with permanent magnets.
- (USA) Inline Helical Geared Motors plus final planetary reduction stage. 1/20 HP DC motors with permanent magnets.
- (IT) Motoriduttori coassiali ad ingranaggi più stadio finale epicicloidale. Motori in corrente continua a magneti permanenti da 37 W.
- (ES) Motorreductores coaxiales de engranajes más etapa final epicicloidale. Motores en corriente continua con imanes permanentes de 37 W.
- (DE) Koaxiale Zahnrad-Getriebemotoren und zusätzlichem Planetenuntersetzungsgetriebe. Gleichstrommotor mit Dauermagneten mit 37 W.
- (FR) Motoréducteurs coaxiaux à engrenages plus étage final épicycloïdal. Moteurs en courant continu à aimants permanents de 37 W.

RPM TORQUE

| | | |
|--|----------|---------------------|
| | 1.6 ÷ 75 | 4.3 ÷ 23.5 Nm |
| | 1.6 ÷ 75 | 38.1 ÷ 208.0 in-lbs |

PA

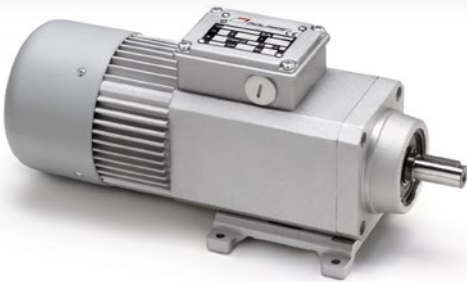

- (EN) Coaxial geared motors. Single-phase and three-phase motors from 34 to 180 W.
- (USA) Inline Helical Geared Motors. Single-phase and three-phase motors from 1/18 to 1/4 HP.
- (IT) Motoriduttori coassiali ad ingranaggi. Motori da 34 a 180 W monofasi o trifasi.
- (ES) Motorreductores coaxiales de engranajes. Motores entre 34 y 180 W monofásicos o trifásicos.
- (DE) Koaxiale Zahnrad-Getriebemotoren. Einphasen-oder Drehstrommotor von 34 bis 180 W.
- (FR) Motoréducteurs coaxiaux à engrenages. Moteurs de 34 à 180 W monophasés ou triphasés.

RPM TORQUE

| | | |
|--|-------------|-------------------|
| | 6.7 ÷ 432 | 1,1 ÷ 20 Nm |
| | 4.5 ÷ 518.0 | 68.1 ÷ 177 in-lbs |

PAC



- (EN) Coaxial geared motors. DC motors from 75 to 150 W with permanent magnets.
- (USA) Inline Helical Geared Motors. DC motors from 1/10 to 1/5 HP with permanent magnets.
- (IT) Motoriduttori coassiali ad ingranaggi. Motori in corrente continua a magneti permanenti da 75 a 150 W.
- (ES) Motorreductores coaxiales de engranajes. Motores en corriente continua con imanes permanentes entre 75 y 150 W.
- (DE) Coaxiale Zahnrad-Getriebemotoren. Gleichstrommotor mit Permanentmagneten von 75 bis 150 W.
- (FR) Motoréducteurs coaxiaux à engrenages. Moteurs en courant continu à aimants permanents de 75 à 150 W.

RPM TORQUE

| | | |
|--|-----------|----------------------|
| | 8,2 ÷ 432 | 1,6 ÷ 20 Nm |
| | 8,2 ÷ 432 | 14.14 ÷ 176.8 in-lbs |

PAE



- (EN) Coaxial geared motors plus final planetary reduction stage. Single-phase and three-phase motors from 34 to 180 W.
- (USA) Inline Helical Geared Motors plus final planetary reduction stage. Single-phase and three-phase motors from 1/18 to 1/4 HP.
- (IT) Motoriduttori coassiali ad ingranaggi più stadio finale epicicloidale. Motori da 34 a 180 W monofasi o trifasi.
- (ES) Motorreductores coaxiales de engranajes más etapa final epicicloidale. Motores entre 34 y 180 W monofásicos o trifásicos.
- (DE) Koaxiale Zahnrad-Getriebemotoren mit zusätzlichem Planetenuntersetzungsgetriebe. Einphasen-oder Drehstrommotor von 34 bis 180 W.
- (FR) Motoréducteurs coaxiaux à engrenages plus étage final épicycloïdal. Moteurs de 34 à 180 W monophasés et triphasés.

RPM TORQUE

| | | |
|--|------------|---------------------|
| | 0,7 ÷ 57 | 8,1 ÷ 90 Nm |
| | 0.8 ÷ 68.8 | 71.7 ÷ 796.5 in-lbs |

PACE



- (EN) Coaxial geared motors plus final planetary reduction stage. DC motors from 75 to 150 W with permanent magnets.
- (USA) Inline Helical Geared Motors plus final planetary reduction stage. DC motors from 1/10 to 1/5 HP with permanent magnets.
- (IT) Motoriduttori coassiali ad ingranaggi più stadio finale epicicloidale. Motori in corrente continua a magneti permanenti da 75 a 150 W.
- (ES) Motorreductores coaxiales de engranajes más etapa final epicicloidale. Motores en corriente continua con imanes permanentes entre 75 y 150 W.
- (DE) Koaxiale Zahnrad-Getriebemotoren mit zusätzlichem Planetenuntersetzungsgetriebe. Gleichstrommotor mit Permanentmagneten von 75 bis 150 W.
- (FR) Motoréducteurs coaxiaux à engrenages plus étage final épicycloïdal. Moteurs en courant continu à aimants permanents de 75 à 150 W.

| | RPM | TORQUE |
|--|----------|---------------------|
| | 1,7 ÷ 57 | 11,2 ÷ 90 Nm |
| | 1.7 ÷ 57 | 99.1 ÷ 796.5 in-lbs |

BC2000



- (EN) Wormed geared motors. Single-phase and three-phase motors till 20 W. Centre distance 20 mm.
- (USA) Wormed geared motors. Single-phase and three-phase motors till 1/32 HP. Centre distance 0.787 in.
- (IT) Motoriduttori a vite senza fine. Motori monofase e trifase con potenza fino a 20 W. Interasse 20 mm.
- (ES) Motorreductores de tornillo sin fin. Motores monofásicos y trifásicos con potencias de hasta 20 W. Distancia entre ejes de 20 mm.
- (DE) Schneckengetriebemotoren. Einphasig, und Dreiphasigmotoren mit Leistung bis 20 W. Achsenstand 20 mm.
- (FR) Motoréducteurs à vis sans fin. Moteurs monophasés ou triphasés jusqu'à 20 W. Entraxe 20 mm.

| | RPM | TORQUE |
|--|----------|-------------------|
| | 35 ÷ 280 | 0,59 ÷ 3,05 Nm |
| | 42 ÷ 336 | 5.2 ÷ 27.0 in-lbs |

BC2000-24MP



- (EN) Wormed geared motors. DC motors till 37 W. Centre distance 20 mm.
- (USA) Wormed geared motors. DC motors till 1/20 HP. Centre distance 0.787 in.
- (IT) Motoriduttori a vite senza fine. Motori in corrente continua fino a 37 W. Interasse 20 mm.
- (ES) Motorreductores de tornillo sin fin. Motores en corriente continua de hasta 37 W. Distancia entre ejes de 20 mm.
- (DE) Schneckengetriebemotoren. Gleichstrommotoren mit 37 W. Achsenstand 20 mm.
- (FR) Motoréducteurs à vis sans fin. Moteurs en courant continu jusqu'à 37 W. Entraxe 20 mm.

| | RPM | TORQUE |
|--|----------|-------------------|
| | 35 ÷ 280 | 1,11 ÷ 5,2 Nm |
| | 35 ÷ 280 | 9.8 ÷ 46.0 in-lbs |

BCE2000

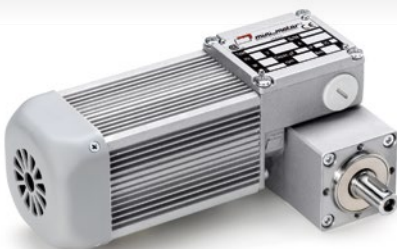

- (EN) Wormed geared motors plus final planetary reduction stage. Single-phase and three-phase motors till 20 W. Centre distance 20 mm.
- (USA) Wormed geared motors plus final planetary reduction stage. Single-phase and three-phase motors till 1/32 HP. Centre distance 0.787 in.
- (IT) Motoriduttori a vite senza fine più stadio finale epicicloidale. Motori monofase e trifase con potenza fino a 20 W. Interasse 20 mm.
- (ES) Motorreductores de tornillo sin fin más etapa final epicicloidale. Motores monofásicos y trifásicos con potencias de hasta 20 W. Distancia entre ejes de 20 mm.
- (DE) Schneckengetriebemotoren und Planetenuntersetzungsgetriebe. Einphasig, und Dreiphasigmotoren mit Leistung bis 20 W. Achsenstand 20 mm.
- (FR) Motoréducteurs à vis sans fin plus étage final épicycloïdal. Moteurs monophasés ou triphasés jusqu'à 20 W. Entraxe 20 mm.

| | RPM | TORQUE |
|--|------------|---------------------|
| | 7 ÷ 56 | 2,8 ÷ 14,4 Nm |
| | 8.4 ÷ 67.2 | 24.8 ÷ 127.4 in-lbs |

BCE2000-24MP



- (EN) Wormed geared motors plus final planetary reduction stage. DC motors till 37 W. Centre distance 20 mm.
- (USA) Wormed geared motors plus final planetary reduction stage. DC motors till 1/20 HP. Centre distance 0.787 in.
- (IT) Motoriduttori a vite senza fine più stadio finale epicicloidale. Motori in corrente continua a 37 W. Interasse 20 mm.
- (ES) Motorreductores de tornillo sin fin más etapa final epicicloidale. Motores en corriente continua de hasta 37 W. Distancia entre ejes de 20 mm.
- (DE) Schneckengetriebemotoren und Planetenuntersetzunggetriebe. Gleichstrommotoren mit 37 W. Achsenstand 20 mm.
- (FR) Motoréducteurs à vis sans fin plus étage final épicycloïdal. Moteurs en courant continu jusqu'à 37 W. Entraxe 20 mm.

| | RPM | TORQUE |
|--|----------|---------------------|
| | 8,1 ÷ 56 | 5,27 ÷ 15 Nm |
| | 8.1 ÷ 56 | 46.6 ÷ 132.8 in-lbs |

MC

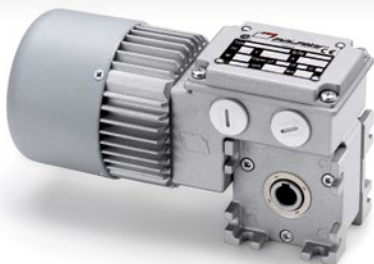

- (EN) Worm geared motors. Single-phase and three-phase motors from 14 to 180 W. Centre Distance 26 mm.
- (USA) Worm geared motors. Single-phase and three-phase motors from 1/40 to 1/4 HP. Centre Distance 1.02 in.
- (IT) Motoriduttori a vite senza fine. Motori da 14 a 180 W monofase o trifasi. Interasse 26 mm.
- (ES) Motorreductores de tornillo sin fin. Motores entre 14 y 180 W monofásicos o trifásicos. Distancia entre ejes de 26 mm.
- (DE) Schneckengetriebemotoren. Einphasen-oder Drehstrommotor von 14 bis 180 W. Achsenstand 26 mm.
- (FR) Motoréducteurs à vis sans fin. Moteurs de 14 à 180 W monophasés ou triphasés. Entraxe 26 mm.

| | RPM | TORQUE |
|--|----------|------------------|
| | 23 ÷ 560 | 0,5 ÷ 13 Nm |
| | 28 ÷ 672 | 4.4 ÷ 115 in-lbs |

MCC



- (EN) Worm geared motors. DC motors from 37 to 150 W with permanent magnets. Centre Distance 26 mm.
- (USA) Worm geared motors. DC motors from 1/20 to 1/5 HP with permanent magnets. Centre Distance 1.02 in.
- (IT) Motoriduttori a vite senza fine. Motori in corrente continua a magneti permanenti da 37 a 150 W. Interasse 26 mm.
- (ES) Motorreductores de tornillo sin fin. Motores en corriente continua con imanes permanentes entre 37 y 150 W. Distancia entre ejes de 26 mm.
- (DE) Schneckengetriebemotoren. Gleichstrommotor mit Dauermagneten von 37 bis 150 W. Achsenstand 26 mm.
- (FR) Motoréducteurs à vis sans fin. Moteurs en courant continu à aimants permanents de 37 à 150 W. Entraxe 26 mm.

| | RPM | TORQUE |
|--|----------|------------------|
| | 35 ÷ 560 | 0,4 ÷ 13 Nm |
| | 35 ÷ 560 | 3.5 ÷ 115 in-lbs |

MCE



- (EN) Worm geared motors plus final planetary reduction stage. Single-phase and three-phase motors from 14 to 180 W. Centre distance 26 mm.
- (USA) Worm geared motors plus final planetary reduction stage. Single-phase and three-phase motors from 1/40 to 1/4 HP. Centre distance 1.02 in.
- (IT) Motoriduttori a vite senza fine più stadio finale epicicloidale. Motori da 14 a 180 W monofasi o trifasi. Interasse 26 mm.
- (ES) Motorreductores de tornillo sin fin más etapa final epicicloidale. Motores entre 14 y 180 W monofásicos o trifásicos. Distancia entre ejes de 26 mm.
- (DE) Schneckengetriebemotoren mit zusätzlichem und Planetenuntersetzunggetriebe. Einphasen-oder Drehstrommotor von 14 bis 180 W. Achsenstand 26 mm.
- (FR) Motoréducteurs à vis sans fin plus étage final épicycloïdal. Moteurs de 14 à 180 W monophasés et triphasés. Entraxe 26 mm.

| | RPM | TORQUE |
|--|----------|---------------------|
| | 3,5 ÷ 74 | 3,4 ÷ 23,5 Nm |
| | 4 ÷ 90 | 30.1 ÷ 208.0 in-lbs |

MCCE



- (EN) Worm geared motors plus final planetary reduction stage. DC motors from 37 to 150 W with permanent magnets. Centre distance 26 mm.
- (USA) Worm geared motors plus final planetary reduction stage. DC motors from 1/20 to 1/5 HP with permanent magnets. Centre distance 1.02 in.
- (IT) Motoriduttori a vite senza fine più stadio finale epicicloidale. Motori in corrente continua a magneti permanenti da 37 a 150 W. Interasse 26 mm.
- (ES) Motorreductores de tornillo sin fin más etapa final epicicloidale. Motores en corriente continua con imanes permanentes entre 37 y 150 W. Distancia entre ejes de 26 mm.
- (DE) Schneckengetriebemotoren mit zusätzlichem und Planetenuntersetzungsgetriebe. Gleichstrommotor mit Dauermagneten von 37 bis 150 W. Achsenstand 26 mm.
- (FR) Motorréducteurs à vis sans fin plus étage final épicycloïdal. Moteurs en courant continu à aimants permanents de 37 à 150 W. Entraxe 26 mm.

| | RPM | TORQUE |
|--|----------|---------------------|
| | 7,6 ÷ 74 | 2,8 ÷ 23.5 Nm |
| | 7.6 ÷ 74 | 24.8 ÷ 208.0 in-lbs |

PC



- (EN) Worm geared motors. Single-phase and three-phase motors from 44 to 270 W. Centre distance 32 mm.
- (USA) Worm geared motors. Single-phase and three-phase motors from 1/14 to 1/2 HP. Centre distance 1.26 in.
- (IT) Motoriduttori a vite senza fine. Motori da 44 a 270 W monofasi o trifasi. Interasse 32 mm.
- (ES) Motorreductores de tornillo sin fin. Motores entre 44 y 270 W monofásicos o trifásicos. Distancia entre ejes de 32 mm.
- (DE) Schneckengetriebemotoren. Einphasen-oder Drehstrommotor von 44 bis 270 W. Achsenstand 32 mm.
- (FR) Motorréducteurs à vis sans fin. Moteurs de 44 à 270 W monophasés ou triphasés. Entraxe 32 mm.

| | RPM | TORQUE |
|--|----------|---------------------|
| | 14 ÷ 560 | 1,5 ÷ 20 Nm |
| | 17 ÷ 672 | 13.3 ÷ 115.0 in-lbs |

PCC

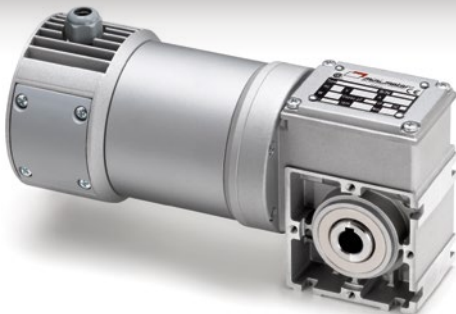

- (EN) Worm geared motors. DC motors from 75 to 150 W with permanent magnets. Centre distance 32 mm.
- (USA) Worm geared motors. DC motors from 1/10 to 1/5 HP with permanent magnets. Centre distance 1.26 in.
- (IT) Motoriduttori a vite senza fine. Motori in corrente continua a magneti permanenti da 75 a 150 W. Interasse 32 mm.
- (ES) Motorreductores de tornillo sin fin. Motores en corriente continua con imanes permanentes entre 75 y 150 W. Distancia entre ejes de 32 mm.
- (DE) Schneckengetriebemotoren. Gleichstrommotor mit Dauermagneten von 75 bis 150 W. Achsenstand 32 mm.
- (FR) Motorréducteurs à vis sans fin. Moteurs en courant continu à aimants permanents de 75 à 150 W. Entraxe 32 mm.

| | RPM | TORQUE |
|--|----------|---------------------|
| | 28 ÷ 560 | 1,1 ÷ 18 Nm |
| | 28 ÷ 560 | 15.0 ÷ 159.3 in-lbs |

PCE



- (EN) Worm geared motors plus final planetary reduction stage. Single-phase and three-phase motors from 44 to 270 W. Centre distance 32 mm.
- (USA) Worm geared motors plus final planetary reduction stage. Single-phase and three-phase motors from 1/14 to 1/2 HP. Centre distance 1.26 in.
- (IT) Motoriduttori a vite senza fine più stadio finale epicicloidale. Motori da 44 a 270 W monofasi o trifasi. Interasse 32 mm.
- (ES) Motorreductores de tornillo sin fin más etapa final epicicloidale. Motores entre 44 y 270 W monofásicos o trifásicos. Distancia entre ejes de 32 mm.
- (DE) Schneckengetriebemotoren mit zusätzlichem Planetenuntersetzungsgetriebe. Einphasen-oder drehstrommotor von 44 bis 270 W. Achsenstand 32 mm.
- (FR) Motorréducteurs à vis sans fin plus étage final épicycloïdal. Moteurs de 44 à 270 W monophasés et triphasés. Entraxe 32 mm.

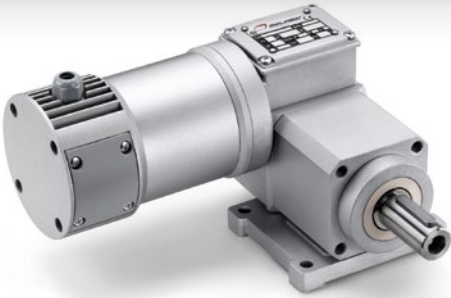

| | RPM | TORQUE |
|--|-----------|-----------------|
| | 3 ÷ 84 | 10,4 ÷ 90 Nm |
| | 3.6 ÷ 101 | 92 ÷ 797 in-lbs |

PCCE



- (EN) Worm geared motors plus final planetary reduction stage. DC motors from 75 to 150 W with permanent magnets. Centre distance 32 mm.
- (USA) Worm geared motors plus final planetary reduction stage. DC motors from 1/10 to 1/5 HP with permanent magnets. Centre distance 1.26 in.
- (IT) Motoriduttori a vite senza fine più stadio finale epicicloidale. Motori in corrente continua a magneti permanenti da 75 a 150 W. Interasse 32 mm.
- (ES) Motorreductores de tornillo sin fin más etapa final epicicloidale. Motores en corriente continua con imanes permanentes entre 75 y 150 W. Distancia entre ejes de 32 mm.
- (DE) Schneckengetriebemotoren mit zusätzlichem Planetenuntersetzungs-getriebe. Gleichstrommotor mit Dauermagneten von 75 bis 150 W. Achsenstand 32 mm.
- (FR) Motoréducteurs à vis sans fin plus étage final épicycloïdal. Moteurs en courant continu à aimants permanents de 75 à 150 W. Entraxe 32 mm.

RPM TORQUE



| | | |
|----------------------------------------------------------------------------------|--------|-----------------|
|  | 6 ÷ 84 | 7.7 ÷ 81 Nm |
|  | 6 ÷ 84 | 68 ÷ 717 in-lbs |

XC



- (EN) Worm geared motors. Three-phase motors from 250 to 740 W. Centre distance 38 mm.
- (USA) Worm geared motors. Three-phase motors from 1/3 to 1 HP. Centre distance 1.5 in.
- (IT) Motoriduttori a vite senza fine. Motori da 250 a 740 W trifasi. Interasse 38 mm.
- (ES) Motorreductores de tornillo sin fin. Motores entre 250 y 740 W trifásicos. Distancia entre ejes de 38 mm.
- (DE) Schneckengetriebemotoren. Drehstrommotor von 250 bis 740 W. Achsenstand 38 mm.
- (FR) Motoréducteurs à vis sans fin. Moteurs de 250 à 740 W triphasés. Entraxe 38 mm.

RPM TORQUE

| | | |
|------------------------------------------------------------------------------------|------------|---------------------|
|  | 14,8 ÷ 590 | 5,8 ÷ 35 Nm |
|  | 17.8 ÷ 709 | 51.4 ÷ 309.8 in-lbs |

MINIACTION 400-500



- (EN) Digital Drive (**Inverter**): Asynchronous three-phase motors up to 0.75 kW.
- (USA) Digital Drive (**Inverter**): Asynchronous three-phase motors up to 1 HP.
- (IT) Azionamento Digitale (**Inverter**): Motori asincroni trifase fino a 0,75 kW.
- (ES) Accionamiento Digital (**Inverter**): Motores asíncronos trifásicos de hasta 0,75 kW.
- (DE) Digitalantrieb (**Inverter**): Drehstrom-Asynchronmotoren bis zu 0,75 kW
- (FR) Actionneur Numérique (**Inverter**): Moteurs asynchrones triphasé jusqu'à 0,75 kW.

POWER

| | |
|------------------------------------------------------------------------------------|-------------|
|  | Up to 750 W |
|  | Up to 1 HP |

DR



- (EN) Digital Drive for asynchronous three-phase motors up to 0,27 kW. Embeddable with the AC - ACE - PA - PAE - MC - MCE - PC - PCE series.
- (USA) Digital drive for asynchronous three-phase motors up to 1/4 HP. Embeddable with the AC - ACE - PA - PAE - MC - MCE - PC - PCE series.
- (IT) Drive digitale per motori asincroni trifase fino a 0,27kW . Integrabile con le serie AC - ACE - PA - PAE - MC - MCE - PC - PCE.
- (ES) Digital drive par motores asinchronos trifásicos de hasta 0,27 kW. Integrable con las series AC - ACE - PA - PAE - MC - MCE - PC - PCE.
- (DE) Digitaldrive fur drehstrom-asynchron motoren bis zu 0,27kW. Integrierbar mit der serie AC - ACE - PA - PAE - MC - MCE - PC - PCE.
- (FR) Digital drive pour moteurs asinchrones thiphasé jusqu'à 0,27 kW. Integrable avec le série AC - ACE - PA - PAE - MC - MCE - PC - PCE.

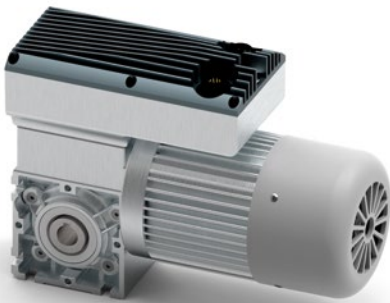

POWER



Up to 270 W



Up to 1/3 HP

DR-BUS



- (EN) Digital Drive with field-bus communication for asynchronous three-phase motors up to 0,27 kW. Embeddable with the AC - ACE - PA - PAE - MC - MCE - PC - PCE series.
- (USA) Digital drive with field-bus communication for asynchronous three-phase motors up to 1/4 HP. Embeddable with the AC - ACE - PA - PAE - MC - MCE - PC - PCE series.
- (IT) Drive digitale con comunicazione field-bus per motori asincroni trifase fino a 0,27kW . Integrabile con le serie AC - ACE - PA - PAE - MC - MCE - PC - PCE.
- (ES) Digital drive con field-bus comunicaciòn par motores asinchronos trifásicos de hasta 0,27 kW. Integrable con las series AC - ACE - PA - PAE - MC - MCE - PC - PCE.
- (DE) Digitaldrive mit field-bus kommunikation fur drehstrom-asynchron motoren bis zu 0,27kW. Integrierbar mit der serie AC - ACE - PA - PAE - MC - MCE - PC - PCE.
- (FR) Digital drive avec field-bus communication pour moteurs asinchrones thiphasé jusqu'à 0,27 kW. Integrable avec le série AC - ACE - PA - PAE - MC - MCE - PC - PCE.

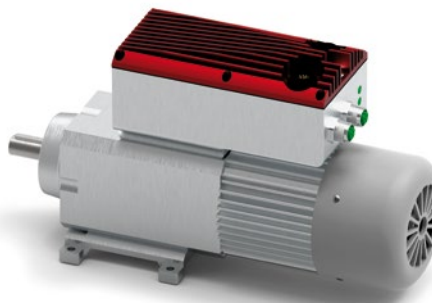
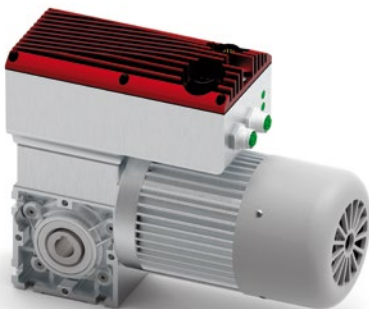

POWER



Up to 270 W



Up to 1/3 HP

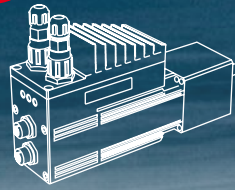

BRUSHLESS



BS35





- (EN) 4-pole sinusoidal brushless motor with resolver. Power from 32 to 61 W. Rated torque from 0,085 to 0,165 Nm. Ø 35 mm.
- (USA) 4-pole sinusoidal brushless motor with resolver. Power from 1/23 to 1/12HP. Rated torque from 0.752 to 1.46 in-lbs. Ø 1.378 in.
- (IT) Motore brushless sinusoidale a 4 poli con resolver. Potenze da 32 a 61 W. Coppie nominali da 0,085 a 0,165 Nm. Ø 35 mm.
- (ES) Motor brushless sinusoidal con 4 polos con resolver. Potencias entre 32 y 61 W. Pares nominales entre 0,085 y 0,165 Nm. Ø 35 mm.
- (DE) 4-poliger sinusförmiger Brushless-Motor mit Resolver. Leistung: 32 bis 61 W. Nennmomente 0,085 - 0,165 Nm. Ø 35 mm.
- (FR) Moteur brushless sinusoidal à 4 pôles avec résolveurs. Puissance de 32 à 61 W. Couple nominal de 0,085 à 0,165 Nm. Ø 35 mm.

| | RPM | TORQUE |
|------------------------------------------------------------------------------------|----------|--------------------|
|  | Max 4000 | 0,075 ÷ 0,145 Nm |
|  | Max 4000 | 0.66 ÷ 1.28 in-lbs |

BSE35





- (EN) Geared motor with bse series brushless servomotor, integrated with precision planetary 1-2 stage reduction unit. Rated torque from 0,29 to 6,5 Nm.
- (USA) Geared motor with bse series brushless servomotor, integrated with precision planetary 1-2 stage reduction unit. Rated torque from 2.567 to 57.53 in-lbs.
- (IT) Motoriduttore con servomotore brushless serie bse, integrato con riduttore ad 1-2 stadi planetario di precisione. Coppie nominali da 0,29 a 6,5 Nm.
- (ES) Motorreductor con servomotor brushless de la serie bse, integrado con reductor de 1-2 etapas, planetario, de precisión. Pares nominales entre 0,29 y 6,5 Nm.
- (DE) Getriebemotor mit brushless-servomotor serie bse, integriert mit präzisions-planetarenuntersetzungsgetriebe mit 1-2 stufen. Nennmomente 0,29 - 6,5 Nm.
- (FR) Motoreducteur avec servomoteur brushless serie bse integre avec un reducteur planetaire de precision a 1-2 etages. Couple nominal de 0,29 à 6,5 Nm.

| | RPM | TORQUE |
|------------------------------------------------------------------------------------|-----------|---------------------|
|  | 82 ÷ 1000 | 0,29 ÷ 6,5 Nm |
|  | 82 ÷ 1000 | 2.57 ÷ 57.53 in-lbs |

BS45





- (EN) 4-pole sinusoidal brushless motor with resolver. Power from 75 to 134 W. Rated torque from 0,200 to 0,340 Nm. Ø 45 mm.
- (USA) 4-pole sinusoidal brushless motor with resolver. Power from 1/10 to 1/5.5 HP. Rated torque from 1.77 to 3.009 in-lbs. Ø 1.77 in.
- (IT) Motore brushless sinusoidale a 4 poli con resolver. Potenze da 75 a 134 W. Coppie nominali da 0,200 a 0,340 Nm. Ø 45 mm.
- (ES) Motor brushless sinusoidal con 4 polos con resolver. Potencias entre 75 y 134 W. Pares nominales entre 0,200 y 0,340 Nm. Ø 45 mm.
- (DE) 4-poliger sinusförmiger Brushless-Motor mit Resolver. Leistung: 75 bis 134 W. Nennmomente 0,200 - 0,340 Nm. Ø 45 mm.
- (FR) Moteur brushless sinusoidal à 4 pôles avec résolveurs. Puissance de 75 à 134 W. Couple nominal de 0,200 à 0,340 Nm. Ø 45 mm.

| | RPM | TORQUE |
|------------------------------------------------------------------------------------|----------|--------------------|
|  | Max 4000 | 0,18 ÷ 0,32 Nm |
|  | Max 4000 | 1.59 ÷ 2.83 in-lbs |

BSE45





- (EN) Geared motor with bse series brushless servomotor, integrated with precision planetary 1-2 stage reduction unit. Rated torque from 0,86 to 14,6 Nm.
- (USA) Geared motor with bse series brushless servomotor, integrated with precision planetary 1-2 stage reduction unit. Rated torque from 7.611 to 129.2 in-lbs.
- (IT) Motoriduttore con servomotore brushless serie bse, integrato con riduttore ad 1-2 stadi planetario di precisione. Coppie nominali da 0,86 a 14,6 Nm.
- (ES) Motorreductor con servomotor brushless de la serie bse, integrado con reductor de 1-2 etapas, planetario, de precisión. Pares nominales entre 0,86 y 14,6 Nm.
- (DE) Getriebemotor mit brushless-servomotor serie bse, integriert mit präzisionsplanetenuntersetzungsgetriebe mit 1-2 stufen. Nennmomente 0,86 - 14,6 Nm.
- (FR) Motoreducteur avec servomoteur brushless serie bse integre avec un reducteur planetaire de precision a 1-2 etages. Couple nominal de 0,86 à 14,6 Nm.

| | RPM | TORQUE |
|----------------------------------------------------------------------------------|----------|---------------------|
|  | 82 ÷ 800 | 0,86 ÷ 146 Nm |
|  | 82 ÷ 800 | 7.61 ÷ 129.2 in-lbs |

BS55





- (EN) 4-pole sinusoidal brushless motor with resolver. Power from 188 to 293 W. Rated torque from 0,500 to 0,900 Nm. Ø 55 mm.
- (USA) 4-pole sinusoidal brushless motor with resolver. Power from 1/4 to 1/2.5 HP. Rated torque from 4.425 to 7.965 in-lbs. Ø 0.98 in.
- (IT) Motore brushless sinusoidale a 4 poli con resolver. Potenze da 188 a 293 W. Coppie nominali da 0,500 a 0,900 Nm. Ø 55 mm.
- (ES) Motor brushless sinusoidal con 4 polos con resolver. Potencias entre 188 y 293 W. Pares nominales entre 0,500 y 0,900 Nm. Ø 55 mm.
- (DE) 4-poliger sinusförmiger Brushless-Motor mit Resolver. Leistung: 188 bis 293 W. Nennmomente 0,500 - 0,900 Nm. Ø 55 mm.
- (FR) Moteur brushless sinusoidal à 4 pôles avec résolveurs. Puissance de 188 à 293 W. Couple nominal de 0,500 à 0,900 Nm. Ø 55 mm.

| | RPM | TORQUE |
|------------------------------------------------------------------------------------|----------|--------------------|
|  | Max 4000 | 0,45 ÷ 0,70 Nm |
|  | Max 4000 | 3.98 ÷ 6.20 in-lbs |

BSE55





- (EN) Geared motor with bse series brushless servomotor, integrated with precision planetary 1-2 stage reduction unit. Rated torque from 2,2 to 31,2 Nm.
- (USA) Geared motor with bse series brushless servomotor, integrated with precision planetary 1-2 stage reduction unit. Rated torque from 19.47 to 276.1 in-lbs.
- (IT) Motoriduttore con servomotore brushless serie bse, integrato con riduttore ad 1-2 stadi planetario di precisione. Coppie nominali da 2,2 a 31,2 Nm.
- (ES) Motorreductor con servomotor brushless de la serie bse, integrado con reductor de 1-2 etapas, planetario, de precisión. Pares nominales entre 2,2 y 31,2 Nm.
- (DE) Getriebemotor mit brushless-servomotor serie bse, integriert mit präzisionsplanetenuntersetzungsgetriebe mit 1-2 stufen. Nennmomente 2,2 - 31,2 Nm.
- (FR) Motoreducteur avec servomoteur brushless serie bse integre avec un reducteur planetaire de precision a 1-2 etages. Couple nominal de 2,2 à 31,2 Nm.

| | RPM | TORQUE |
|------------------------------------------------------------------------------------|----------|----------------------|
|  | 82 ÷ 800 | 2,2 ÷ 31,2 Nm |
|  | 82 ÷ 800 | 19.47 ÷ 276.1 in-lbs |

BS80





- (EN) 4-pole sinusoidal brushless motor with resolver. Power from 460 to 880 W. Rated torque from 1,2 to 2,4 Nm. Ø 80 mm.
- (USA) 4-pole sinusoidal brushless motor with resolver. Power from 1/1.6 to 1.2 HP. Rated torque from 10.65 to 20.35 in-lbs. Ø 3.15 in.
- (IT) Motore brushless sinusoidale a 4 poli con resolver. Potenze da 460 a 880 W. Coppie nominali da 1,2 a 2,4 Nm. Ø 80 mm.
- (ES) Motor brushless sinusoidal con 4 polos con resolver. Potencias entre 460 y 880 W. Pares nominales entre 1,2 y 2,4 Nm. Ø 80 mm.
- (DE) 4-poliger sinusförmiger Brushless-Motor mit Resolver. Leistung: 460 bis 880 W. Nennmomente 1,2 - 2,4 Nm. Ø 80 mm.
- (FR) Moteur brushless sinusoidal à 4 pôles avec résolveurs. Puissance de 460 à 880 W. Couple nominal de 1,2 à 2,4 Nm. Ø 80 mm.

| | RPM | TORQUE |
|------------------------------------------------------------------------------------|----------|---------------------|
|  | Max 4000 | 1,1 ÷ 2,1 Nm |
|  | Max 4000 | 9.74 ÷ 18.59 in-lbs |

BSE80





- (EN) Geared motor with bse series brushless servomotor, integrated with precision planetary 1-2 stage reduction unit. Rated torque from 5,28 to 94,7 Nm.
- (USA) Geared motor with bse series brushless servomotor, integrated with precision planetary 1-2 stage reduction unit. Rated torque from 46.73 to 838.1 in-lbs.
- (IT) Motoriduttore con servomotore brushless serie bse, integrato con riduttore ad 1-2 stadi planetario di precisione. Coppie nominali da 5,28 a 94,7 Nm.
- (ES) Motorreductor con servomotor brushless de la serie bse, integrado con reductor de 1-2 etapas, planetario, de precisión. Pares nominales entre 5,28 y 94,7 Nm.
- (DE) Getriebemotor mit brushless-servomotor serie bse, integriert mit präzisions-planeteneruntersetzungsgetriebe mit 1-2 stufen. Nennmomente 5,28 - 94,7 Nm.
- (FR) Motoreducteur avec servomoteur brushless serie bse integre avec un reducteur planetaire de precision a 1-2 etages. Couple nominal de 5,28 à 94,7 Nm.

| | RPM | TORQUE |
|----------------------------------------------------------------------------------|----------|----------------------|
|  | 82 ÷ 800 | 5,28 ÷ 94,7 Nm |
|  | 82 ÷ 800 | 46.73 ÷ 838.1 in-lbs |

MCBS





- (EN) Worm geared motors plus. Motor: 4 poles sinusoidal brushless motor, totally enclosed. Rated torque from 1,5 to 13 Nm. Rotor with NdFeB magnets.
- (USA) Worm geared motors plus. Motor: 4 poles sinusoidal brushless motor, totally enclosed. Rated torque from 13,28 to 115 in-lbs. Rotor with NdFeB magnets.
- (IT) Motoriduttori a vite senza fine. Motore: brushless sinusoidale a 4 poli, in forma chiusa. Coppie nominali da 1,5 a 13 Nm. Rotore con magneti NdFeB.
- (ES) Motorreductores de tornillo sin fin. Motor: Sinusoidales de 4 polos, en forma cerrada. Pares nominales entre 1,5 y 13 Nm. Rotor con imanes NdFeB.
- (DE) Schneckengetriebemotoren. Motor: 4-polige Sinusmotoren in geschlossener Ausführung. Nennmomente 1,5 - 13 Nm. Rotor mit NdFeBr- Magneten.
- (FR) Motoréducteurs à vis sans fin. Moteur: Sinusoidal à 4 pôles, fermé. Couple nominal de 1,5 à 13 Nm. Rotor avec aimants NdFeB.

| | RPM | TORQUE |
|------------------------------------------------------------------------------------|------------|--------------------|
|  | 37,5 ÷ 600 | 1,5 ÷ 13 Nm |
|  | 37,5 ÷ 600 | 13.28 ÷ 115 in-lbs |

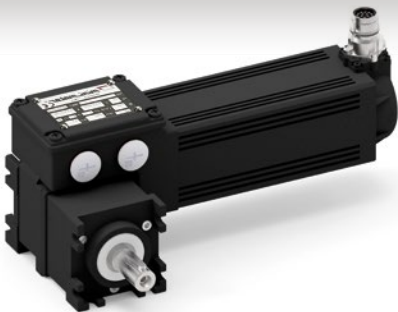
MCEBS





- (EN) Worm geared motors plus final planetary reduction stage. Motor: 4 poles sinusoidal brushless motor, totally enclosed. Rated torque from 10,5 to 23,5 Nm. Rotor with NdFeB magnets.
- (USA) Worm geared motors plus final planetary reduction stage. Motor: 4 poles sinusoidal brushless motor, totally enclosed. Rated torque from 93 to 208 Nm. Rotor with NdFeB magnets.
- (IT) Motoriduttori a vite senza fine più stadio finale epicicloidale. Motore: brushless sinusoidale a 4 poli, in forma chiusa. Coppie nominali da 10,5 a 23,5 Nm. Rotore con magneti NdFeB.
- (ES) Motorreductores de tornillo sin fin más etapa final epicicloidal. Motor: Sinusoidales de 4 polos, en forma cerrada. Pares nominales entre 10,5 y 23,5 Nm. Rotor con imanes NdFeB.
- (DE) Schneckengetriebemotoren mit zusätzlichem und Planeteneruntersetzungsgetriebe. Motor: 4-polige Sinusmotoren in geschlossener Ausführung. Nennmomente 10,5 - 23,5 Nm. Rotor mit NdFeBr- Magneten.
- (FR) Motoréducteurs à vis sans fin plus étage final épicycloidal. Moteur: Sinusoidal à 4 pôles, fermé. Couple nominal de 10,5 à 23,5 Nm. Rotor avec aimants NdFeB.

| | RPM | TORQUE |
|------------------------------------------------------------------------------------|----------|-----------------|
|  | 7,5 ÷ 80 | 10,5 ÷ 23,5 Nm |
|  | 7,5 ÷ 80 | 93 ÷ 208 in-lbs |

MINIACTION 200-300



- (EN) Digital Drive: AC Brushless servomotors up to 2.3 Nm.
- (USA) Digital Drive: AC Brushless servomotors up to 19.5 in-lbs.
- (IT) Azionamento Digitale: AC Brushless servomotors fino a 2,3 Nm.
- (ES) Accionamiento Digital: Servomotores AC Brushless de hasta 2,3 Nm.
- (DE) Digitalantrieb: Brushless-AC-Servomotoren bis zu 2,3 Nm.
- (FR) Actionneur Numerique: Servomoteurs brushless CA jusqu'à 2,3 Nm.

| | TORQUE |
|------------------------------------------------------------------------------------|-------------------|
|  | Up to 2,3 Nm |
|  | Up to 19,5 in-lbs |

DBS



- (EN) Brushless servomotors with integrated drive. Power from 125 to 250 W.
- (USA) Brushless servomotors with integrated drive. Power from 1/6 to 1/3 HP.
- (IT) Servomotori brushless con azionamento integrato. Potenze da 125 a 250 W.
- (ES) Servomotores Brushless Con Accionamiento Integrado. Potencias entre 125 y 250 W.
- (DE) Brushless-Servomotoren mit integriertem Antrieb. Leistung: 125 bis 250 W.
- (FR) Servomoteurs Brushless À Contrôleur Intégré. Puissance de 125 à 250 W.

| | RPM | TORQUE |
|--|----------|--------------------|
| | Max 3000 | 0,4 ÷ 0,75 Nm |
| | Max 3000 | 3.54 ÷ 6.64 in-lbs |

DBSE

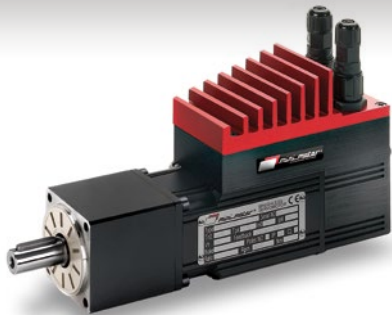

- (EN) Brushless servomotors with integrated drive and planetary reduction gear. Rated torque from 2,2 to 36,5 Nm.
- (USA) Brushless servomotors with integrated drive and planetary reduction gear. Rated torque from 19.47 to 323 in-lbs.
- (IT) Servomotori brushless con azionamento integrato e riduttore epicicloidale. Coppie nominali da 2,2 a 36,5 Nm.
- (ES) Servomotores brushless con accionamiento integrado y reductor epicicloidal. Pares nominales entre 2,2 y 36,5 Nm.
- (DE) Brushless-Servomotoren mit integriertem Antrieb und planetengetriebe. Nennmomente 2,2 - 36,5 Nm.
- (FR) Servomoteurs brushless à contrôleur intégré et réducteur épicycloidal. Couple nominal de 2,2 à 36,5 Nm.

| | RPM | TORQUE |
|--|----------|--------------------|
| | 61 ÷ 600 | 2,2 ÷ 36,5 Nm |
| | 61 ÷ 600 | 19.47 ÷ 323 in-lbs |

MCDBS



- (EN) Brushless servomotors with integrated drive and worm screw reduction gear. Rated torque 13 Nm.
- (USA) Brushless servomotors with integrated drive and worm screw reduction gear. Rated torque 115 in-lbs.
- (IT) Servomotori brushless con azionamento integrato e riduttore a vite senza fine. Coppia nominale 13 Nm.
- (ES) Servomotores brushless con accionamiento integrado y reductor de tornillo sin fin. Pares nominales 13 Nm.
- (DE) Brushless-Servomotoren mit integriertem Antrieb und Schneckengetriebe. Nennmomente 13 Nm.
- (FR) Servomoteurs brushless à contrôleur intégré et réducteur à vis sans fin. Couple nominal 13 Nm.

| | RPM | TORQUE |
|--|------------|--------------------|
| | 37,5 ÷ 600 | 1,5 ÷ 13 Nm |
| | 37,5 ÷ 600 | 13,28 ÷ 115 in-lbs |

MCEDBS



- (EN) Brushless servomotors with integrated drive and worm screw reduction gear plus final planetary reduction stage. Rated torque 23,5 Nm.
- (USA) Brushless servomotors with integrated drive and worm screw reduction gear plus final planetary reduction stage. Rated torque 208 in-lbs.
- (IT) Servomotori brushless con azionamento integrato e riduttore a vite senza fine più stadio finale epicicloidale. Coppia nominale 23,5 Nm.
- (ES) Servomotores brushless con accionamiento integrado y reductor de tornillo sin fin más etapa final epicicloidal. Pares nominales 23,5 Nm.
- (DE) Brushless-Servomotoren mit integriertem Antrieb und Schneckengetriebe. Nennmomente 23,5 Nm.
- (FR) Servomoteurs brushless à contrôleur intégré et réducteur à vis sans fin plus étage final épicycloidal. Couple nominal 23,5 Nm.

| | RPM | TORQUE |
|--|----------|------------------|
| | 7,5 ÷ 80 | 12,9 ÷ 23,5 Nm |
| | 7,5 ÷ 80 | 114 ÷ 208 in-lbs |



DBS-S3



- (EN) Brushless servomotors with integrated drive. S3 intermittent periodic duty. Power from 150 to 285 W.
- (USA) Brushless servomotors with integrated drive. S3 intermittent periodic duty. Power from 1/5 to 1/2.5 HP.
- (IT) Servomotori brushless con azionamento integrato. Servizio intermittente S3. Potenze da 150 a 285 W.
- (ES) Servomotores Brushless Con Accionamiento Integrado. Servicio intermitente S3. Potencias entre 150 y 285 W.
- (DE) Brushless-Servomotoren mit integriertem Antrieb. Aussetzbetrieb S3. Leistung: 150 bis 285 W.
- (FR) Servomoteurs Brushless À Contrôleur Intégré. Service intermittent S3. Puissance de 150 à 285 W.

| | RPM | TORQUE |
|--|----------|--------------------|
| | Max 3000 | 0,48 ÷ 0,90 Nm |
| | Max 3000 | 4.25 ÷ 7.97 in-lbs |



DBSE-S3



- (EN) Brushless servomotors with integrated drive and planetary reduction gear. S3 intermittent periodic duty. Rated torque from 2,6 to 43,8 Nm.
- (USA) Brushless servomotors with integrated drive and planetary reduction gear. S3 intermittent periodic duty. Rated torque from 23.4 to 387.6 in-lbs.
- (IT) Servomotori brushless con azionamento integrato e riduttore epicicloidale. Servizio intermittente S3. Coppie nominali da 2,6 a 43,8 Nm.
- (ES) Servomotores brushless con accionamiento integrado y reductor epicicloidal. Servicio intermitente S3. Pares nominales entre 2,6 y 43,8 Nm.
- (DE) Brushless-Servomotoren mit integriertem Antrieb und planetengetriebe. Aussetzbetrieb S3. Nennmomente 2,6 - 43,8 Nm.
- (FR) Servomoteurs brushless à contrôleur intégré et réducteur épicycloïdal. Service intermittent S3. Couple nominal de 2,6 à 43,8 Nm.

| | RPM | TORQUE |
|--|----------|---------------------|
| | 61 ÷ 600 | 2,6 ÷ 43,8 Nm |
| | 61 ÷ 600 | 23.4 ÷ 387.6 in-lbs |



MCDBS-S3



- (EN) Brushless servomotors with integrated drive and worm screw reduction gear. S3 intermittent periodic duty. Rated torque 13 Nm.
- (USA) Brushless servomotors with integrated drive and worm screw reduction gear. S3 intermittent periodic duty. Rated torque 115 in-lbs.
- (IT) Servomotori brushless con azionamento integrato e riduttore a vite senza fine. Servizio intermittente S3. Coppia nominale 13 Nm.
- (ES) Servomotores brushless con accionamiento integrado y reductor de tornillo sin fin. Servicio intermitente S3. Pares nominales 13 Nm.
- (DE) Brushless-Servomotoren mit integriertem Antrieb und Schneckengetriebe. Aussetzbetrieb S3. Nennmomente 13 Nm.
- (FR) Servomoteurs brushless à contrôleur intégré et réducteur à vis sans fin. Service intermittent S3. Couple nominal 13 Nm.

| | RPM | TORQUE |
|--|------------|-------------------|
| | 37,5 ÷ 600 | 2,2 ÷ 13 Nm |
| | 37,5 ÷ 600 | 19.5 ÷ 115 in-lbs |



MCEDBS-S3



- (EN) Brushless servomotors with integrated drive and worm screw reduction gear plus final planetary reduction stage. S3 intermittent periodic duty. Rated torque 23,5 Nm.
- (USA) Brushless servomotors with integrated drive and worm screw reduction gear plus final planetary reduction stage. S3 intermittent periodic duty. Rated torque 208 in-lbs.
- (IT) Servomotori brushless con azionamento integrato e riduttore a vite senza fine più stadio finale epicicloidale. Servizio intermittente S3. Coppia nominale 23,5 Nm.
- (ES) Servomotores brushless con accionamiento integrado y reductor de tornillo sin fin más etapa final epicicloidal. Servicio intermitente S3. Pares nominales 23,5 Nm.
- (DE) Brushless-Servomotoren mit zusätzlichem und Planetenuntersetzunggetriebe. Aussetzbetrieb S3. Nennmomente 23,5 Nm.
- (FR) Servomoteurs brushless à contrôleur intégré et réducteur à vis sans fin plus étage final épicycloïdal. Service intermittent S3. Couple nominal 23,5 Nm.

| | RPM | TORQUE |
|--|----------|------------------|
| | 7,5 ÷ 80 | 15,5 ÷ 23,5 Nm |
| | 7,5 ÷ 80 | 137 ÷ 208 in-lbs |

CLEAN

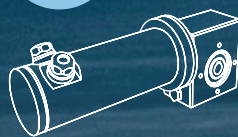

(EN) Motors may be supplied with epoxy painting or with anodic treatment.

(USA) Motors may be supplied with epoxy painting or with anodic treatment.

(IT) Ordinabili con verniciatura epossidica o con trattamento anodico.

(ES) Es posible suministrar los motores con pintura epoxy o tratamiento anódico.

(DE) Die Motoren können mit epoxidfarbe oder anodischer be andlung bestellt werden.

(FR) Il est possible de livrer les moteurs avec époxy peinture or avec traitement anodique.

CLEAN

ACF

IP67



| | RPM | TORQUE |
|--|-----|--------|
|--|-----|--------|

| | | |
|--|-----------|-------------------|
| | 6,3 ÷ 378 | 0,8 ÷ 5 Nm |
| | 7.6 ÷ 453 | 7.1 ÷ 44.3 in-lbs |

(EN) Inline helical geared motors. 31 W three-phase motors.

(USA) Inline helical geared motors. Three-phase motors 1/24 HP.

(IT) Motoriduttori coassiali ad ingranaggi. Motori 31 W trifasi.

(ES) Motorreductores coaxiales de engranajes. Motores 31 W trifásicos.

(DE) Koaxiale Zahnrad-Getriebemotoren. Drehstrommotor 31 W.

(FR) Motoréducteurs coaxiaux à engrenages. Moteurs 31 W triphasés.

CLEAN

ACEF

IP67

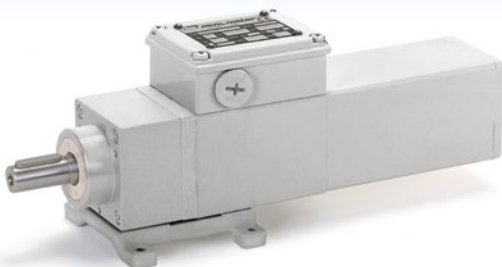

| | RPM | TORQUE |
|--|-----|--------|
|--|-----|--------|

| | | |
|--|----------|-------------------|
| | 1,2 ÷ 75 | 3,9 ÷ 23,5 Nm |
| | 1.4 ÷ 90 | 34.5 ÷ 208 in-lbs |

(EN) Inline helical geared motors plus final planetary reduction stage. Three-phase motors 31 W.

(USA) Inline helical geared motors plus final planetary reduction stage. Three-phase motors 1/24 HP.

(IT) Motoriduttori coassiali ad ingranaggi più stadio finale epicicloidale. Motori 31 W trifasi.

(ES) Motorreductores coaxiales de engranajes más etapa final epicicloidale. Motores 31 W trifásicos.

(DE) Koaxiale Zahnrad-Getriebemotoren mit zusätzlichem und Planetenuntersetzunggetriebe. Drehstrommotor 31 W.

(FR) Motoréducteurs coaxiaux à engrenages plus étage final épicycloïdal. Moteurs 31 W triphasés.

CLEAN

PAF

IP67



| | RPM | TORQUE |
|--|-----|--------|
|--|-----|--------|

| | | |
|--|-----------|-------------------|
| | 7,5 ÷ 432 | 2,8 ÷ 20 Nm |
| | 9 ÷ 518 | 24.8 ÷ 177 in-lbs |

(EN) Inline helical geared motors. 130 W three-phase motors.

(USA) Inline helical geared motors. Single-phase and three-phase motors 1/5.6 HP.

(IT) Motoriduttori coassiali ad ingranaggi. Motori 130 W trifasi.

(ES) Motorreductores coaxiales de engranajes. Motores 130 W trifásicos.

(DE) Koaxiale Zahnrad-Getriebemotoren. Drehstrommotor 130 W.

(FR) Motoréducteurs coaxiaux à engrenages. Moteurs 130 W triphasés.

CLEAN

PAEF

IP67



- Ⓔ EN Inline helical geared motors plus final planetary reduction stage. Three-phase motors 130 W.
- Ⓔ USA Inline helical geared motors plus final planetary reduction stage. Three-phase motors 1/5,6 HP.
- Ⓔ IT Motoriduttori coassiali ad ingranaggi più stadio finale epicicloidale. Motori 130 W trifasi.
- Ⓔ ES Motorreductores coaxiales de engranajes más etapa final epicicloidale. Motores 130 W trifásicos.
- Ⓔ DE Koaxiale Zahnrad-Getriebemotoren mit zusätzlichem und Planetenuntersetzungsgetriebe. Drehstrommotor 130 W.
- Ⓔ FR Motorréducteurs coaxiaux à engrenages plus étage final épicycloïdal. Moteurs 130 W triphasés.

RPM TORQUE

| | | |
|----------------------------------------------------------------------------------|------------|------------------|
|  | 1,5 ÷ 57 | 19,9 ÷ 90 Nm |
|  | 1,8 ÷ 68.4 | 176 ÷ 797 in-lbs |

CLEAN

MCF

IP67



- Ⓔ EN Worm geared motors plus. 31 - 88 W three-phase motors. Centre distance 26 mm.
- Ⓔ USA Worm geared motors. Single-phase and three-phase motors 1/24 HP. Centre Distance 1.02 in.
- Ⓔ IT Motoriduttori a vite senza fine. Motori trifase 31 - 88 W. Interasse 26 mm.
- Ⓔ ES Motorreductores de tornillo sin fin. Motores 31 - 88 W trifásicos. Distancia entre ejes de 26 mm.
- Ⓔ DE Schneckengetriebemotoren. Drehstrommotor 31 - 88 W. Achsenstand 26 mm.
- Ⓔ FR Motorréducteurs à vis sans fin. Moteurs 31 - 88 W triphasés. Entraxe 26 mm.

RPM TORQUE

| | | |
|------------------------------------------------------------------------------------|----------|-------------------|
|  | 35 ÷ 560 | 0,5 ÷ 6,4 Nm |
|  | 42 ÷ 672 | 4.4 ÷ 56.6 in-lbs |

CLEAN

MCEF

IP67



- Ⓔ EN Worm geared motors plus final planetary reduction stage. Three-phase motors 31 and 88 W. Centre distance 26 mm.
- Ⓔ USA Worm geared motors plus final planetary reduction stage. Three-phase motors 1/24 and 1/10 HP. Centre Distance 1.02 in.
- Ⓔ IT Motoriduttori a vite senza fine più stadio finale epicicloidale. Motori trifase 31 e 88 W. Interasse 26 mm.
- Ⓔ ES Motorreductores de tornillo sin fin más etapa final epicicloidale. Motores 31 y 88 W trifásicos. Distancia entre ejes de 26 mm.
- Ⓔ DE Schneckengetriebemotoren mit zusätzlichem und Planetenuntersetzungsgetriebe. Drehstrommotor 31 und 88 W. Achsenstand 26 mm.
- Ⓔ FR Motorréducteurs à vis sans fin plus étage final épicycloïdal. Moteurs 31 et 88 W triphasés. Entraxe 26 mm.

RPM TORQUE

| | | |
|------------------------------------------------------------------------------------|----------|-------------------|
|  | 7 ÷ 74 | 3,9 ÷ 23,5 Nm |
|  | 8.4 ÷ 89 | 34.5 ÷ 208 in-lbs |

CLEAN



PCF

IP67



- Ⓔ EN Worm geared motors. 130 - 290 W and three-phase motors. Centre distance 32 mm.
- Ⓔ USA Worm geared motors. Single-phase and three-phase motors 1/5.6 HP. Centre distance 1.26 in.
- Ⓔ IT Motoriduttori a vite senza fine. Motori 130 W trifasi. Interasse 32 mm.
- Ⓔ ES Motorreductores de tornillo sin fin. Motores 130 - 290 W trifásicos. Distancia entre ejes de 32 mm.
- Ⓔ DE Schneckengetriebemotoren. Drehstrommotor 130 - 290 W. Achsenstand 32 mm.
- Ⓔ FR Motorréducteurs à vis sans fin. Moteurs 130 - 290 W triphasés. Entraxe 32 mm.

RPM TORQUE

| | | |
|------------------------------------------------------------------------------------|----------|-------------------|
|  | 28 ÷ 560 | 2 ÷ 20 Nm |
|  | 34 ÷ 672 | 17.7 ÷ 177 in-lbs |

CLEAN

PCEF

IP67



- EN Worm geared motors plus final planetary reduction stage. Three-phase motors 130 and 290 W. Centre distance 32 mm.
- USA Worm geared motors plus final planetary reduction stage. Three-phase motors 1/5,6 to 1/2,6 HP. Centre distance 1.26 in.
- IT Motoriduttori a vite senza fine più stadio finale epicicloidale. Motori di 130 a 290 W trifasi. Interasse 32 mm.
- ES Motorreductores de tornillo sin fin más etapa final epicicloidale. Motores 130 y 290 W trifásicos. Distancia entre ejes de 32 mm.
- DE Schneckengetriebemotoren mit zusätzlichem Planetenuntersetzunggetriebe. Einphasen-oder drehstrommotor 130 und 290 W. Achsenstand 32 mm.
- FR Motoréducteurs à vis sans fin plus étage final épicycloïdal. Moteurs 130 et 290 W monophasés et triphasés. Entraxe 32 mm.

RPM TORQUE

| | | |
|--|-----------|------------------|
| | 6 ÷ 84 | 13,1 ÷ 90 Nm |
| | 7.2 ÷ 101 | 117 ÷ 797 in-lbs |

CLEAN

XCF

IP67



- EN Worm geared motors. Three-phase motors 290 W. Centre distance 38 mm.
- USA Worm geared motors. Three-phase motors 1/2.6 HP. Centre distance 1.5 in.
- IT Motoriduttori a vite senza fine. Motori 290 W trifasi. Interasse 38 mm.
- ES Motorreductores de tornillo sin fin. Motores 290 W trifásicos. Distancia entre ejes de 38 mm.
- DE Schneckengetriebemotoren. Drehstrommotor 290 W. Achsenstand 38 mm.
- FR Motoréducteurs à vis sans fin. Moteurs 290 W triphasés. Entraxe 38 mm.

RPM TORQUE

| | | |
|--|----------|-------------------|
| | 30 ÷ 590 | 9 ÷ 35 Nm |
| | 36 ÷ 709 | 80 ÷ 309.8 in-lbs |

CLEAN

MCFBBS

IP67



- EN Worm geared motors plus. Motor: 4 poles sinusoidal brushless motor, totally enclosed 188 - 293 W. Rotor with NdFeB magnets.
- USA Worm geared motors plus. Motor: 4 poles sinusoidal brushless motor, totally enclosed 1/4 HP. Rotor with NdFeB magnets.
- IT Motoriduttori a vite senza fine. Motore: brushless sinusoidale a 4 poli, in forma chiusa 188 - 293 W. Rotore con magneti NdFeB.
- ES Motorreductores de tornillo sin fin. Motor: Sinusoidales de 4 polos, en forma cerrada 188 - 293 W. Rotor con imanes NdFeB.
- DE Schneckengetriebemotoren. Motor: 4-polige Sinusmotoren in geschlossener Ausführung 188 - 293 W. Rotor mit NdFeBr- Magneten.
- FR Motoréducteurs à vis sans fin. Moteur: Sinusoïdal à 4 pôles, fermé 188 - 293 W. Rotor avec aimants NdFeB.

RPM TORQUE

| | | |
|--|------------|-------------------|
| | 37,5 ÷ 600 | 1,5 ÷ 13 Nm |
| | 37,5 ÷ 600 | 13.3 ÷ 115 in-lbs |

CLEAN

MCEFBS

IP67

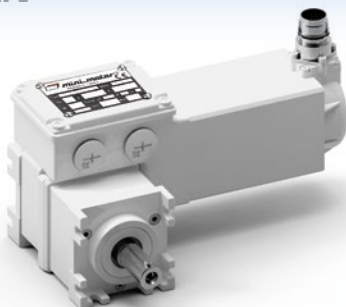

- EN Worm geared motors plus final planetary reduction stage. Motor: 4 poles sinusoidal brushless motor, totally enclosed. Rated torque 23.5 Nm. Rotor with NdFeB magnets.
- USA Worm geared motors plus final planetary reduction stage. Motor: 4 poles sinusoidal brushless motor, totally enclosed. Rated torque 208 in-lbs. Rotor with NdFeB magnets.
- IT Motoriduttori a vite senza fine più stadio finale epicicloidale. Motore: brushless sinusoidale a 4 poli, in forma chiusa. Coppia nominale 23,5 Nm. Rotore con magneti NdFeB.
- ES Motorreductores de tornillo sin fin más etapa final epicicloidale. Motor: Sinusoidales de 4 polos, en forma cerrada. Pares nominales 23,5 Nm. Rotor con imanes NdFeB.
- DE Schneckengetriebemotoren mit zusätzlichem und Planetenuntersetzunggetriebe. Motor: 4-polige Sinusmotoren in geschlossener Ausführung. Nennmomente 23,5 Nm. Rotor mit NdFeBr- Magneten.
- FR Motoréducteurs à vis sans fin plus étage final épicycloïdal. Moteur: Sinusoïdal à 4 pôles, fermé. Couple nominal 23.5 Nm. Rotor avec aimants NdFeB.

RPM TORQUE

| | | |
|--|----------|-----------------|
| | 7,5 ÷ 80 | 10,5 ÷ 23 Nm |
| | 7,5 ÷ 80 | 93 ÷ 208 in-lbs |

CLEAN

DRF

IP67

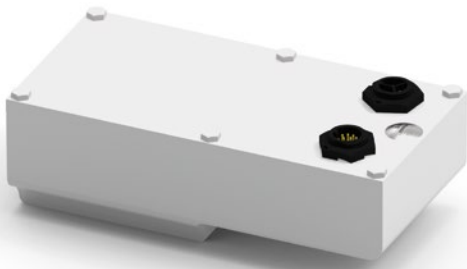

- (EN) Digital Drive for asynchronous three-phase motors up to 0,27 kW. Embeddable with the AC - ACE - PA - PAE - MC - MCE - PC - PCE series.
- (USA) Digital drive for asynchronous three-phase motors up to 1/4 HP. Embeddable with the AC - ACE - PA - PAE - MC - MCE - PC - PCE series.
- (IT) Drive digitale per motori asincroni trifase fino a 0,27kW . Integrabile con le serie AC - ACE - PA - PAE - MC - MCE - PC - PCE.
- (ES) Digital drive par motores asinchronos trifásicos de hasta 0,27 kW. Integrable con las series AC - ACE - PA - PAE - MC - MCE - PC - PCE.
- (DE) Digitaldrive fur drehstrom-asynchron motoren bis zu 0,27kW. Integrierbar mit der serie AC - ACE - PA - PAE - MC - MCE - PC - PCE.
- (FR) Digital drive pour moteurs asinchrones thiphasé jusqu'à 0,27 kW. Integrable avec le série AC - ACE - PA - PAE - MC - MCE - PC - PCE.

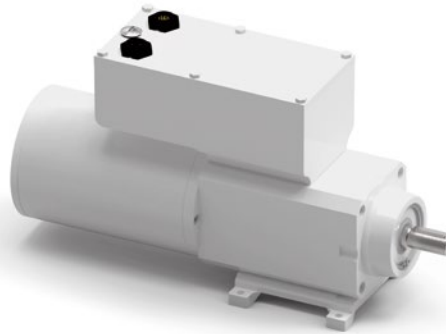
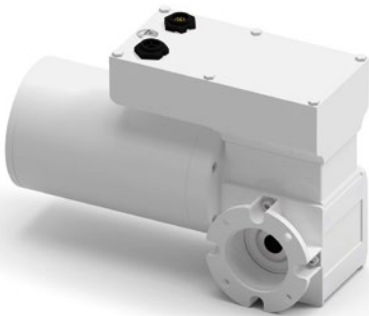

POWER



Up to 150 W



Up to 1/5 HP

CLEAN

DRF-BUS

IP67

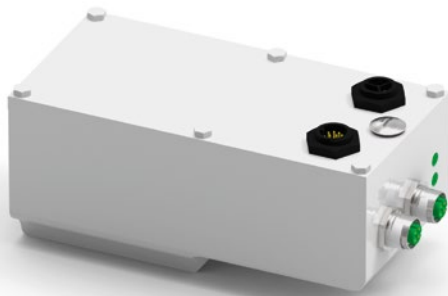

- (EN) Digital Drive with field-bus communication for asynchronous three-phase motors up to 0,27 kW. Embeddable with the AC - ACE - PA - PAE - MC - MCE - PC - PCE series.
- (USA) Digital drive with field-bus communication for asynchronous three-phase motors up to 1/4 HP. Embeddable with the AC - ACE - PA - PAE - MC - MCE - PC - PCE series.
- (IT) Drive digitale con comunicazione field-bus per motori asincroni trifase fino a 0,27kW . Integrabile con le serie AC - ACE - PA - PAE - MC - MCE - PC - PCE.
- (ES) Digital drive con field-bus comunicaciòn par motores asinchronos trifásicos de hasta 0,27 kW. Integrable con las series AC - ACE - PA - PAE - MC - MCE - PC - PCE.
- (DE) Digitaldrive mit field-bus kommunikation fur drehstrom-asynchron motoren bis zu 0,27kW. Integrierbar mit der serie AC - ACE - PA - PAE - MC - MCE - PC - PCE.
- (FR) Digital drive avec field-bus communication pour moteurs asinchrones thiphasé jusqu'à 0,27 kW. Integrable avec le série AC - ACE - PA - PAE - MC - MCE - PC - PCE.

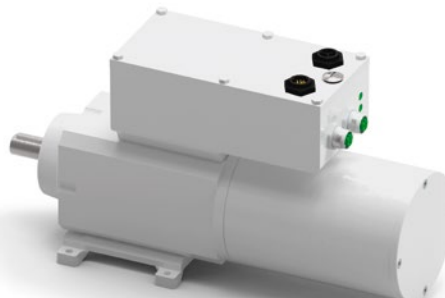
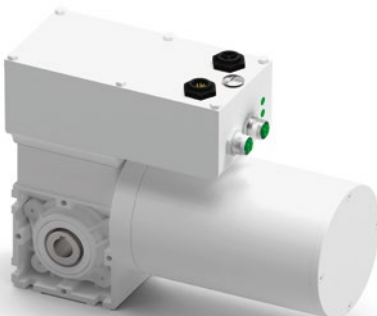

POWER



Up to 150 W



Up to 1/5 HP

CLEAN

AMSS

IP69K



- (EN) Stainless steel sinusoidal brushless servomotor with IP69K protection rating. Conforms to EHEDG. Powers from 94 to 740 W. Torques from 0.3 to 2.35 Nm.
- (USA) Stainless steel sinusoidal brushless servomotor with IP69K protection rating. Conforms to EHEDG. Powers from 1/8 to 1 HP. Torques from 2.66 to 20.80 in-lbs.
- (IT) Servomotori brushless sinusoidali in acciaio INOX con grado di protezione IP69K. Conforme EHEDG. Potenze da 94 a 740 W. Coppie da 0,3 a 2,35 Nm.
- (ES) Servomotores brushless sinusoidales de acero inoxidable con grado de protección IP69K. Conformes a EHEDG. Potencias de 94 a 740 W. Pares de 0,3 a 2,35 Nm.
- (DE) Sinus-Brushless-Servomotoren aus rostfreiem Stahl mit Schutzart IP69K. Die Motoren erfüllen die Anforderungen der Hygiene-Leitlinien EHEDG. Leistungen von 94 bis 740 W. Drehmomente von 0,3 bis 2,35 Nm.
- (FR) Servomoteurs brushless sinusoidaux en acier INOX à indice de protection IP69K. Conformes aux EHEDG. Puissances de 94 à 740 W. Couples de 0,3 à 2,35 Nm.

| | RPM | TORQUE |
|--|----------|--------------------|
| | Max 3000 | 0,3 ÷ 2,35 Nm |
| | Max 3000 | 2.66 ÷ 20.8 in-lbs |

CLEAN

PCFSS

IP69K



- (EN) Stainless steel worm gear motor with AMSS series servomotor. Torques up to 18Nm. 30 mm wheelbase.
- (USA) Stainless steel worm gear motor with AMSS series servomotor. Torques up to 159 in-lbs. 1.181 in. wheelbase.
- (IT) Motoriduttore a vite senza fine in acciaio INOX con servomotore serie AMSS. Coppie fino a 18Nm. Interasse 30 mm.
- (ES) Motorreductor de tornillo sin fin de acero inoxidable con servomotor serie AMSS. Pares de hasta 18 Nm. Distancia entre ejes de 30 mm.
- (DE) Schneckengetriebemotor aus rostfreiem Stahl mit Servomotor Serie AMSS. Drehmomente bis 18 Nm. Achsabstand 30 mm.
- (FR) Motorréducteur à vis sans fin en acier INOX avec servomoteur de la série AMSS. Couples jusqu'à 18 Nm. Entraxe 30 mm.

| | RPM | TORQUE |
|--|----------|---------------------|
| | 38 ÷ 600 | 1,3 ÷ 18 Nm |
| | 38 ÷ 600 | 11.5 ÷ 159.3 in-lbs |

CLEAN

XCFSS

IP69K



- (EN) Stainless steel worm gear motor with AMSS series servomotor. Torques up to 39Nm. 45 mm wheelbase.
- (USA) Stainless steel worm gear motor with AMSS series servomotor. Torques up to 345 in-lbs. 1.772 in. wheelbase.
- (IT) Motoriduttore a vite senza fine in acciaio INOX con servomotore serie AMSS. Coppie fino a 39Nm. Interasse 45 mm.
- (ES) Motorreductor de tornillo sin fin de acero inoxidable con servomotor serie AMSS. Pares de hasta 39 Nm. Distancia entre ejes de 45 mm.
- (DE) Schneckengetriebemotor aus rostfreiem Stahl mit Servomotor Serie AMSS. Drehmomente bis 39 Nm. Achsabstand 45 mm.
- (FR) Motorréducteur à vis sans fin en acier INOX avec servomoteur de la série AMSS. Couples jusqu'à 39 Nm. Entraxe 45 mm.

| | RPM | TORQUE |
|--|----------|---------------------|
| | 28 ÷ 429 | 3,4 ÷ 39 Nm |
| | 28 ÷ 429 | 30.1 ÷ 345.2 in-lbs |

CLEAN

SXCFSS

IP69K

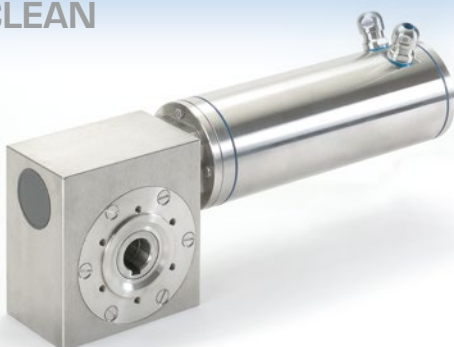

- (EN) Stainless steel worm gear motor with AMSS series servomotor. Torques up to 70Nm. 50 mm wheelbase.
- (USA) Stainless steel worm gear motor with AMSS series servomotor. Torques up to 620 in-lbs. 1.968 in. wheelbase.
- (IT) Motoriduttore a vite senza fine in acciaio INOX con servomotore serie AMSS. Coppie fino a 70Nm. Interasse 50 mm.
- (ES) Motorreductor de tornillo sin fin de acero inoxidable con servomotor serie AMSS. Pares de hasta 70 Nm. Distancia entre ejes de 50 mm.
- (DE) Schneckengetriebemotor aus rostfreiem Stahl mit Servomotor Serie AMSS. Drehmomente bis 70 Nm. Achsabstand 50 mm.
- (FR) Motorréducteur à vis sans fin en acier INOX avec servomoteur de la série AMSS. Couples jusqu'à 70 Nm. Entraxe 50 mm.

| | RPM | TORQUE |
|--|----------|---------------------|
| | 30 ÷ 429 | 6,6 ÷ 70 Nm |
| | 30 ÷ 429 | 58.4 ÷ 619.6 in-lbs |

CLEAN



AMSSE70

IP69K



- (EN) Stainless steel planetary motor with AMSS series servomotor. Torques up to 13,97 Nm.
- (USA) Stainless steel planetary motor with AMSS series servomotor. Torques up to 123,64 in-lbs.
- (IT) Motoriduttore epicicloidale in acciaio INOX con servomotore serie AMSS. Coppie fino a 13,97 Nm.
- (ES) Motorreductor epicicloidal de acero inoxidable con servomotor serie AMSS. Pares de hasta 13,97 Nm.
- (DE) Planetengetriebemotor aus Edelstahl mit Servomotor Serie AMSS. Drehmomente bis 13,97 Nm.
- (FR) Motorréducteur épicycloïdal en acier INOX avec servomoteur de la série AMSS. Couples jusqu'à 13,97 Nm.

RPM TORQUE

| | | |
|----------------------------------------------------------------------------------|----------|----------------------|
|  | 61 ÷ 600 | 1,46 ÷ 13,97 Nm |
|  | 61 ÷ 600 | 12.9 ÷ 123.64 in-lbs |

CLEAN



AMSSE90

IP69K



- (EN) Stainless steel planetary motor with AMSS series servomotor. Torques up to 51,20 Nm.
- (USA) Stainless steel planetary motor with AMSS series servomotor. Torques up to 453,16 in-lbs.
- (IT) Motoriduttore epicicloidale in acciaio INOX con servomotore serie AMSS. Coppie fino a 51,20 Nm.
- (ES) Motorreductor epicicloidal de acero inoxidable con servomotor serie AMSS. Pares de hasta 51,20 Nm.
- (DE) Planetengetriebemotor aus Edelstahl mit Servomotor Serie AMSS. Drehmomente bis 51,20 Nm.
- (FR) Motorréducteur épicycloïdal en acier INOX avec servomoteur de la série AMSS. Couples jusqu'à 51,20 Nm.

RPM TORQUE

| | | |
|------------------------------------------------------------------------------------|----------|-----------------------|
|  | 61 ÷ 600 | 2,81 ÷ 51,20 Nm |
|  | 61 ÷ 600 | 24.87 ÷ 453.16 in-lbs |

CLEAN



AMSSE110

IP69K



- (EN) Stainless steel planetary motor with AMSS series servomotor. Torques up to 109,4 Nm.
- (USA) Stainless steel planetary motor with AMSS series servomotor. Torques up to 968,3 in-lbs.
- (IT) Motoriduttore epicicloidale in acciaio INOX con servomotore serie AMSS. Coppie fino a 109,4 Nm.
- (ES) Motorreductor epicicloidal de acero inoxidable con servomotor serie AMSS. Pares de hasta 109,4 Nm.
- (DE) Planetengetriebemotor aus Edelstahl mit Servomotor Serie AMSS. Drehmomente bis 109,4 Nm.
- (FR) Motorréducteur épicycloïdal en acier INOX avec servomoteur de la série AMSS. Couples jusqu'à 109,4 Nm.

RPM TORQUE

| | | |
|------------------------------------------------------------------------------------|----------|-----------------------|
|  | 61 ÷ 600 | 11,40 ÷ 109,4 Nm |
|  | 61 ÷ 600 | 100.90 ÷ 968.3 in-lbs |

- (EN) Not binding data and specifications. The manufacturer can introduce, without notice, any modification considered as necessary.
- (USA) Not binding data and specifications. The manufacturer can introduce, without notice, any modification considered as necessary.
- (IT) Dati e descrizioni non impegnativi. La ditta costruttrice si riserva di apportare, senza preavviso, tutte le eventuali modifiche ritenute necessarie.
- (ES) Datos y descripciones no vinculantes. La casa constructora se reserva el derecho de aportar, sin previo aviso, todas las eventuales modificaciones que considere necesarias.
- (DE) Die technischen Daten sind unverbindlich. Der Hersteller behält sich da Recht vor, zu jeder Zeit alle erforderlichen Aenderungen vorzunehmen.
- (FR) Données et instructions qui nous n'engagent pas. Le constructeur se réserve la faculté d'apporter, sans préavis toutes les modifications considérées comme nécessaires.





MINI MOTOR - Via Enrico Fermi, 5 - 42011 Bagnolo in Piano (RE) - ITALY - Tel. +39.0522.951889

MINI MOTOR USA - 24-25 46th Street - NY 11103 - USA - Tel. 1 718-943-7422

MINI MOTOR Aandrijftechniek - Wagenmakersweg 8A - 3449 HV WOERDEN (NL) - Tel. +31.6.23317459

MINI MOTOR GERMANY - Alter Kirchpfad 6 - 32657 Lemgo (DL) - Tel. +49 (0) 5261 6600640



COMPLETE SALES NETWORK ON WEBSITE
info@minimotor.com - www.minimotor.com

